

NW-26

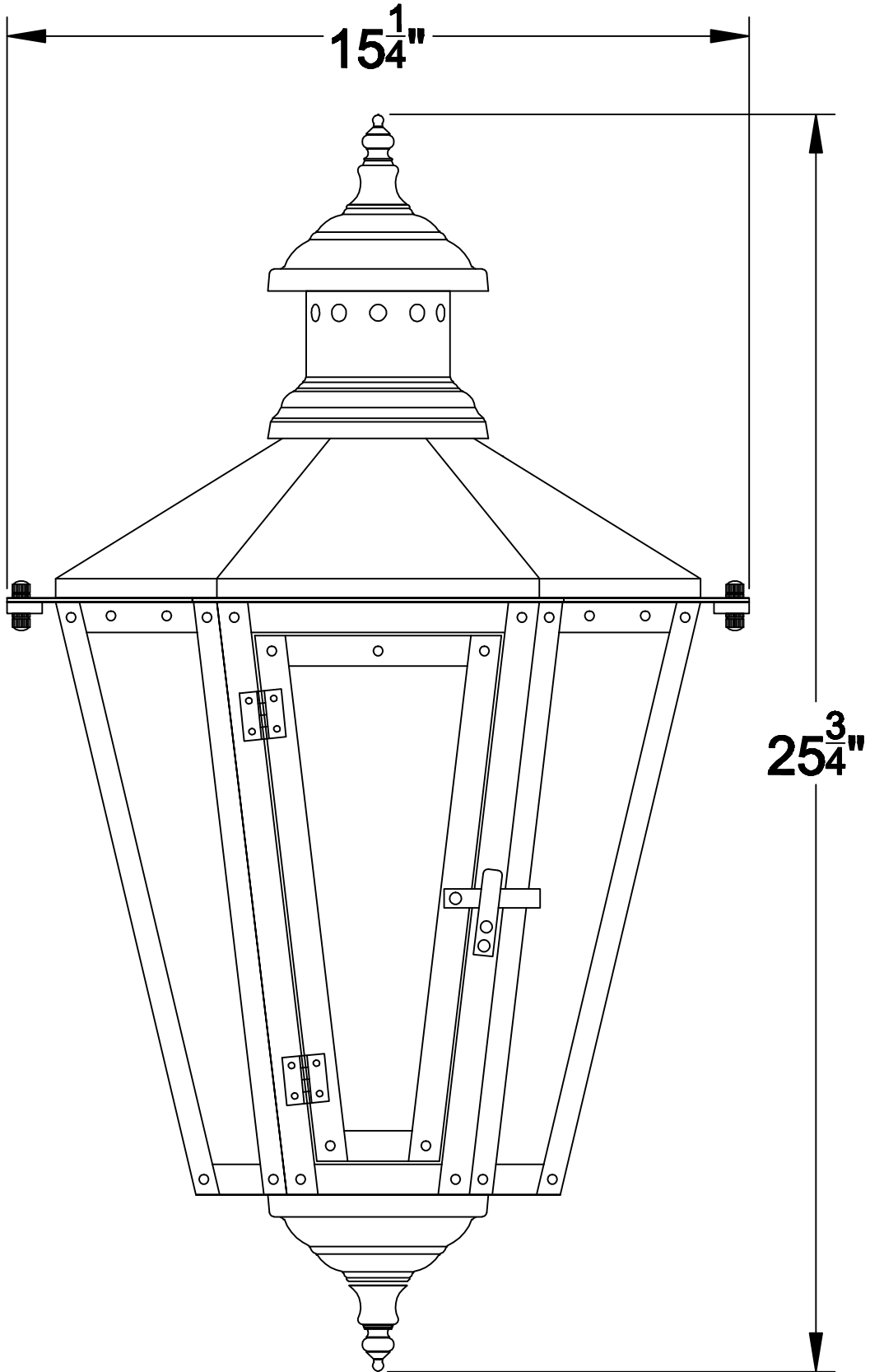

Front

NW-26

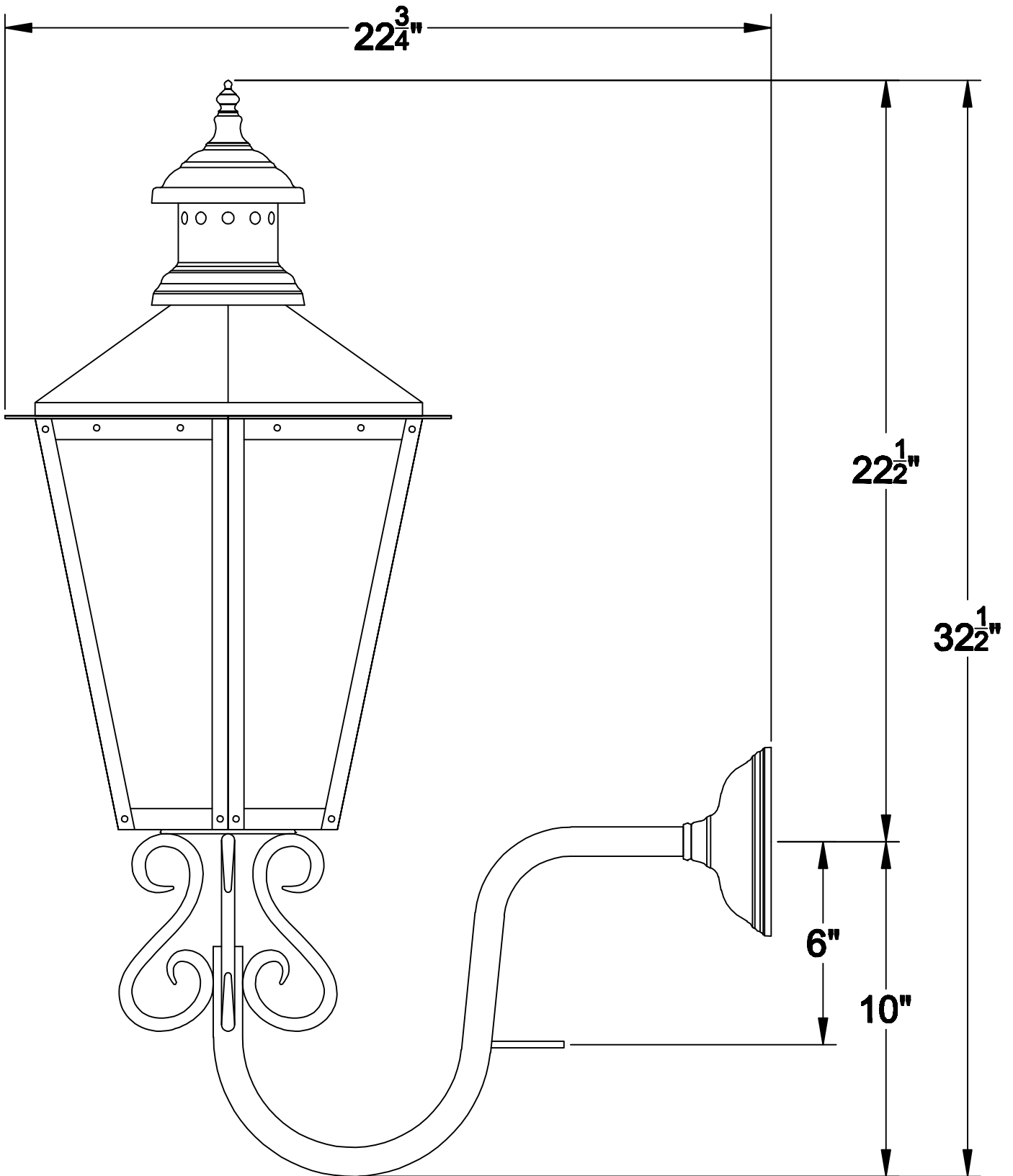

GN

NW-26

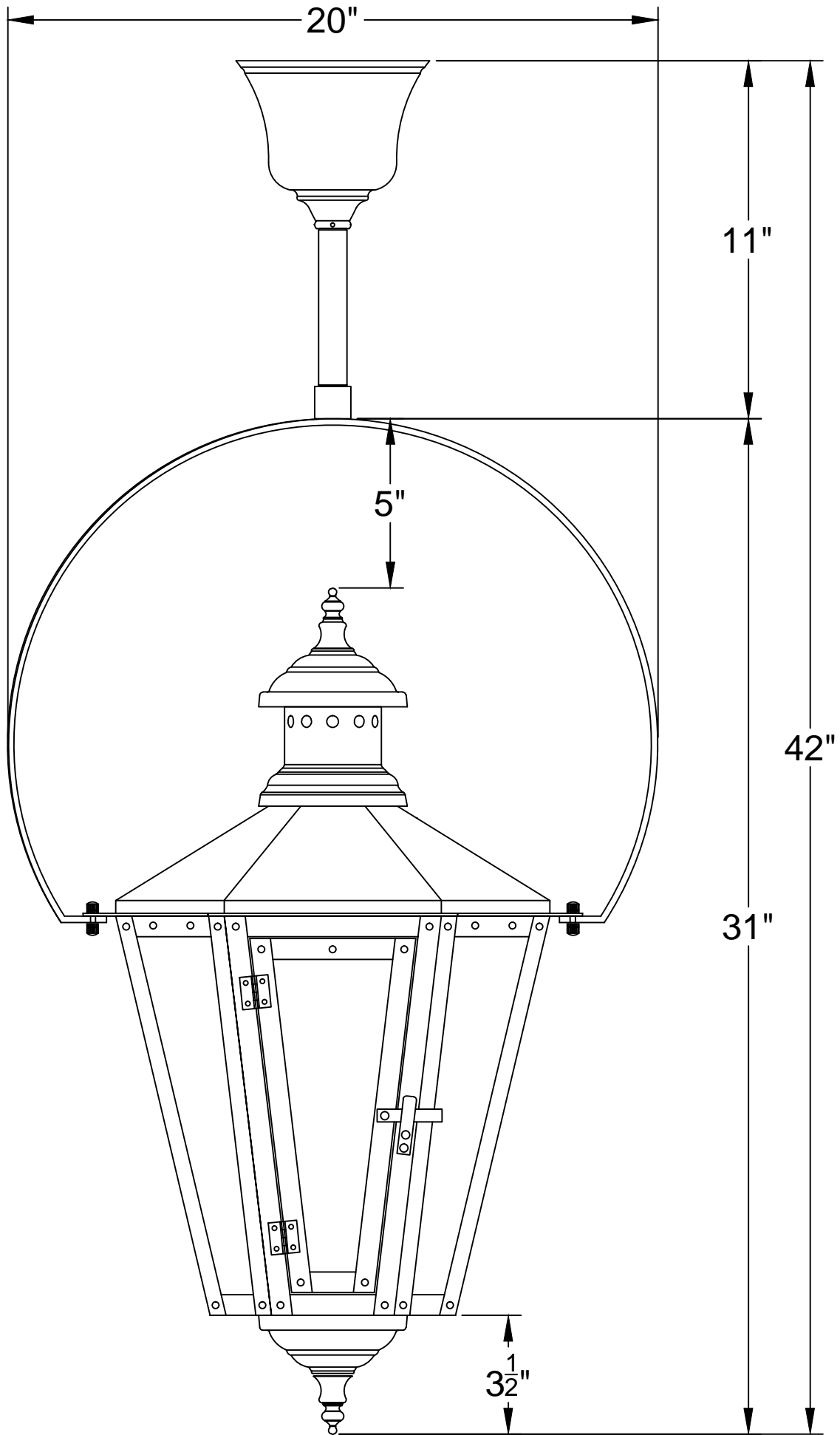

HY-3

NW-26

66 $\frac{3}{4}$ "

25 $\frac{3}{4}$ "

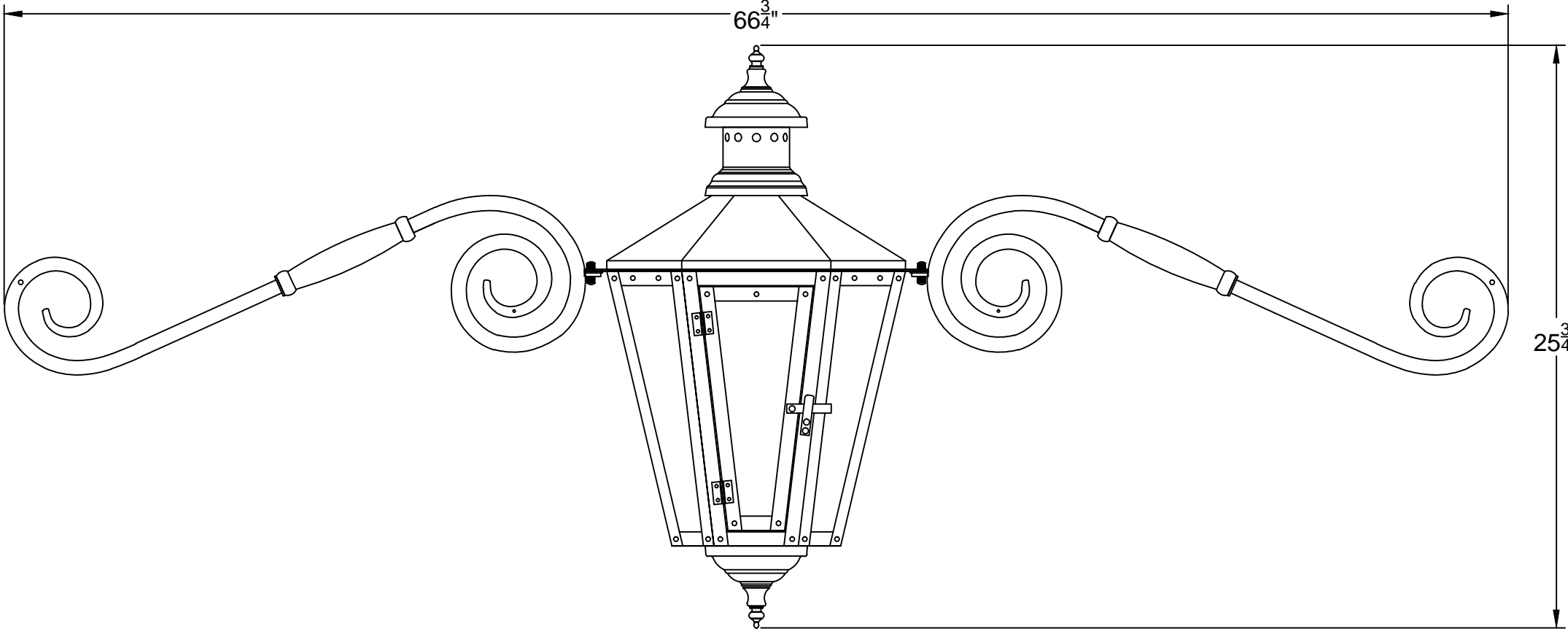

MU

NW-26

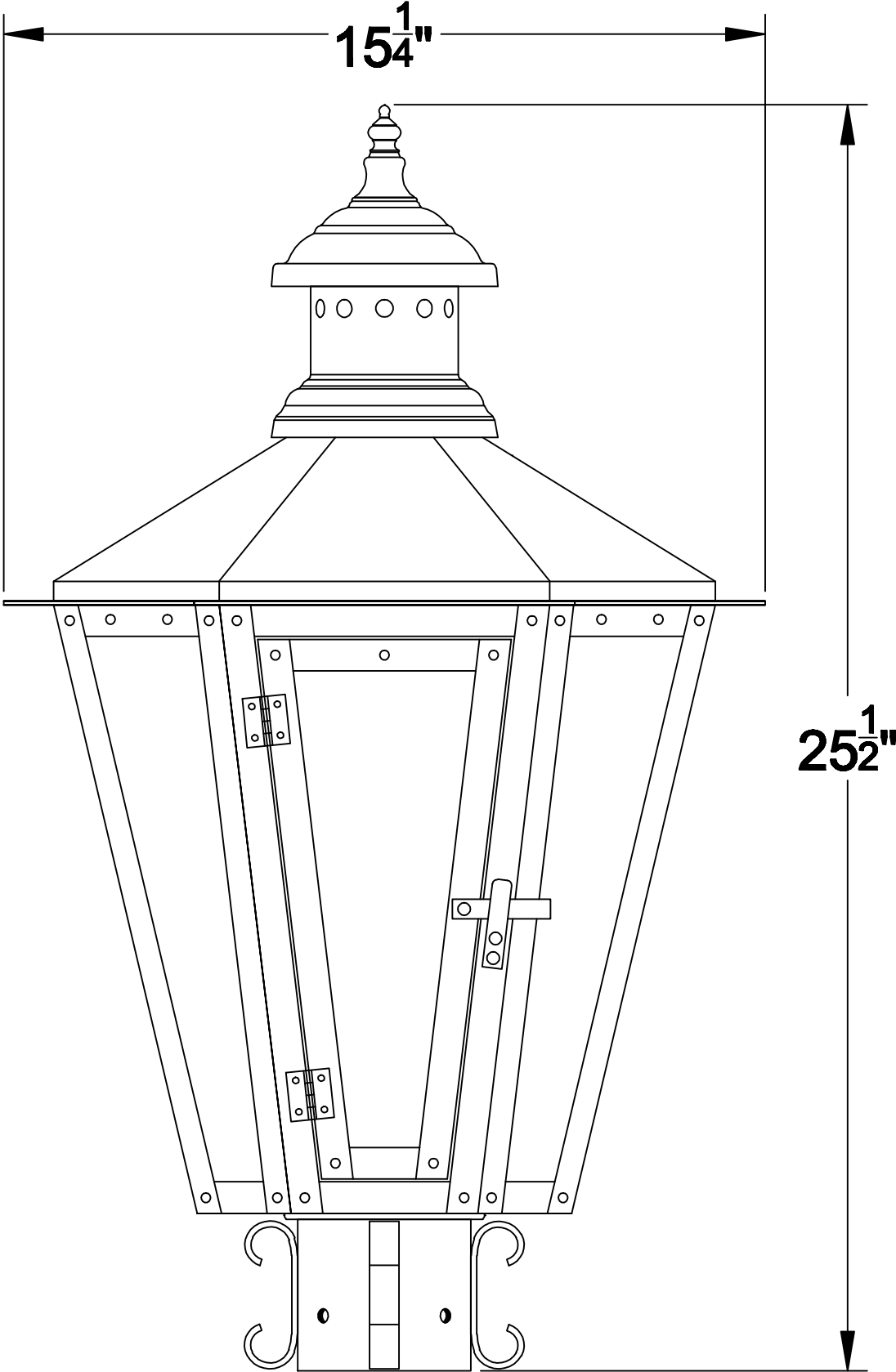

PM

NW-26

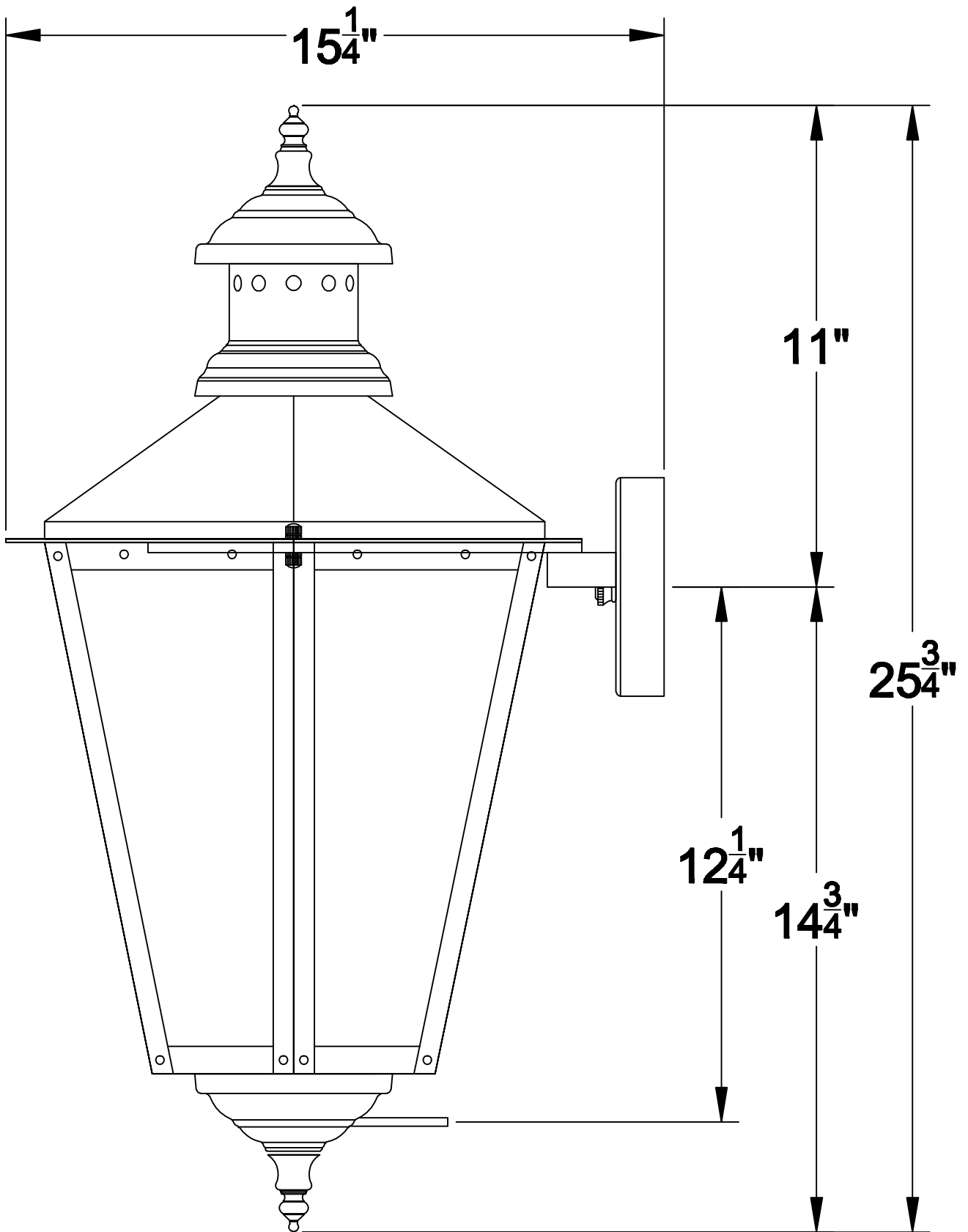

Side

NW-26

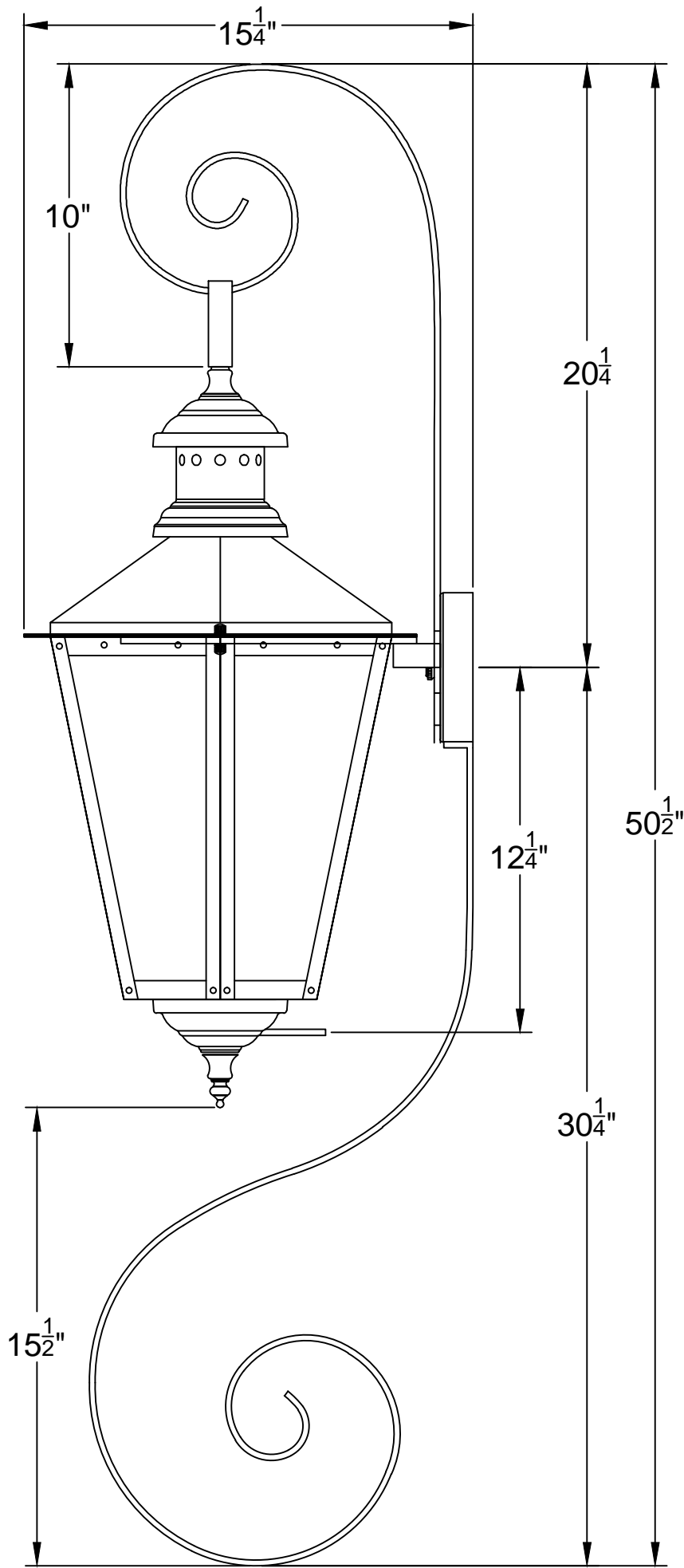

TS-2 BS-2

NW-26

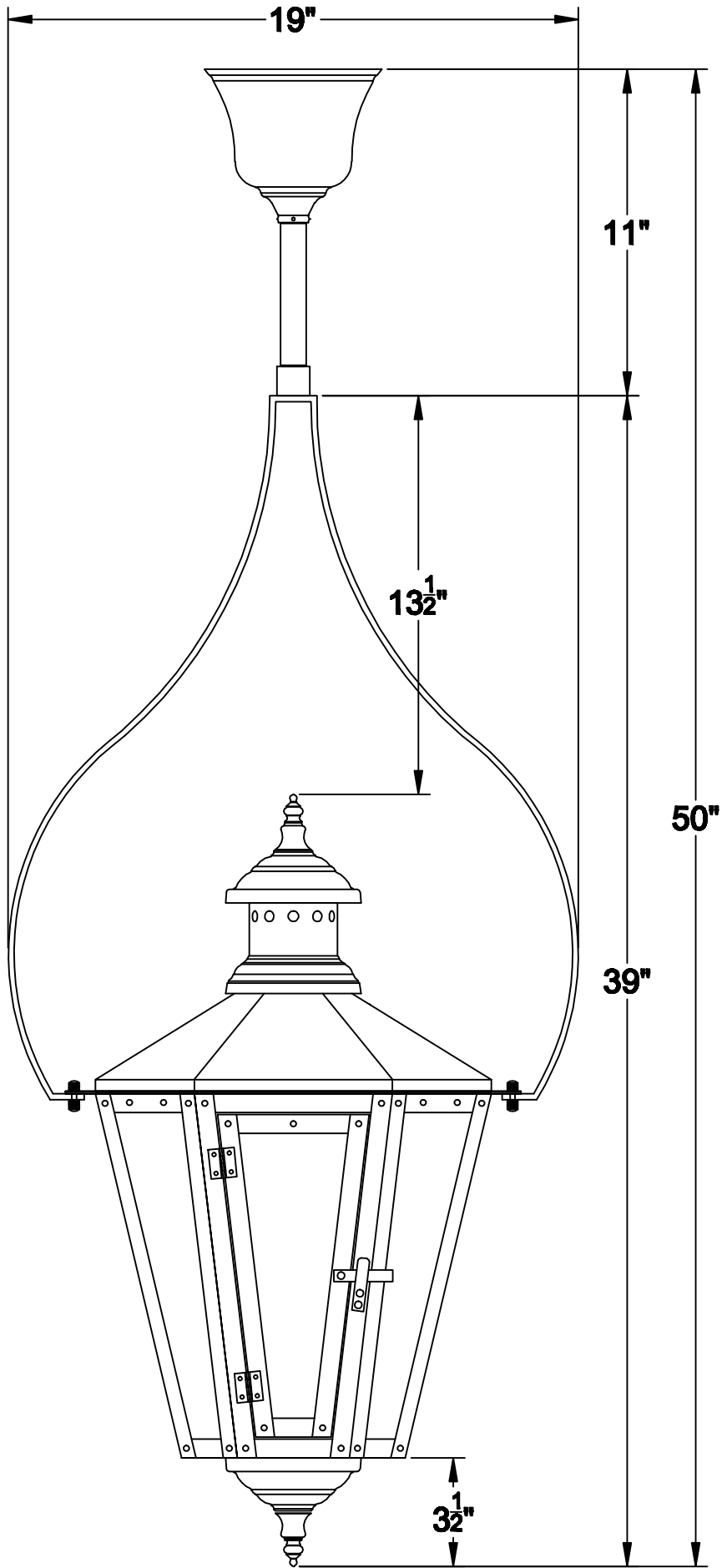

TY-2